

G-26c

UPRIGHT COOLER

G-Series Coolers

FEATURES

- Exterior Dimensions (WDH): 30" x 30.5" x 78.375"
- Internal Volume: 23 ft³
- Dynamic LED Lighting In Door Provides Enhanced Product Illumination While Greatly Reducing Energy Consumption
- Forced Air Refrigeration System For Fast Product Temperature Pull Down
- High Impact Side Panel Graphics & LED Illuminated Canopy
- High Density Environmentally Friendly Insulation
- Utilizes Climate-Friendly Natural Refrigerant
- 4 Fully Adjustable Powder-Coated Metal Shelves
- Double-paned, Low "E", Self-Closing Glass Door
- LED Interior Lighting
- Durable Pre-Painted Steel Cabinet and Heavy Duty Inner Liner
- Adjustable Temperature Control
- 9' Heavy Duty Power Cord

CERTIFICATIONS

110v

- UL471
- NSF/ANSI-7: Type 2 Display Refrigerator
- ENERGY STAR[®] Qualified



G-26c

UPRIGHT COOLER

G-Series Coolers

TECH SPECS

Refrigerant	R290
Amps	2.7
Volts/Hz	110-120V/60Hz
Compressor HP	1/3



SHIPPING SPECS

Gross Weight	319 lbs
Net Weight	278 lbs
Carton Dims (WDH)	30.375"x30.77"x83.625"
Units per Pallet	1
Shipping Options:	
Floor Loaded	20' ~ 21 40'HQ ~ 45 53' ~ 60

DIMENSIONS

Exterior: 30"W x 30.5"D x 78.375"H
 Interior: 26.5"W x 25.125"D x 51.5"H
 Shelf: 25.5"W x 22.625"D
 Internal Volume: 23 ft³

PACKOUT CAPACITIES

	Facings	Deep	Total Capacity	Total Rows
	7 Shelves	10 x 8	= 650*	8
	Base	10 x 9		
	6 Shelves	10 x 8	= 570*	7
	Base	10 x 9		
	4 Shelves	9 x 8	= 360**	5
	Base	9 x 8		

* Additional shelves, beyond what is supplied with the cooler, may be required to achieve this maximum pack-out.
 ** 20oz pack-outs may vary depending on package size.



EXTERIOR DIMENSIONS

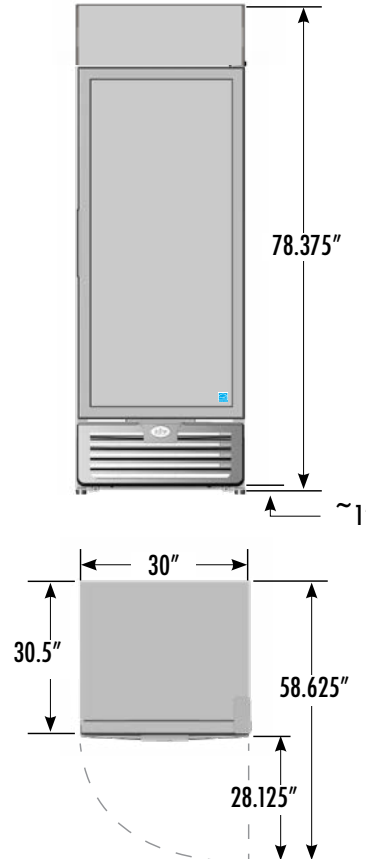

INTERIOR DIMENSIONS

